

Features

- $S_{21} = 28.6 \text{ dB @ 1400 MHz}$
= 27.4 dB @ 1600 MHz
- NF of 0.60 dB over Frequency
- Unconditionally Stable
- Single 5V Supply
- High OIP3 @ Low Current

Description

The plerow™ ALN-series is the compactly designed surface-mount module for the use of the LNA with or without the following gain blocks in the infrastructure equipment of the mobile wireless (CDMA, GSM, PCS, PHS, WCDMA, DMB, WLAN, WiBro, WiMAX), GPS, satellite communication terminals, CATV and so on. It has an exceptional performance of low noise figure, high gain, high OIP3, and low bias current. The stability factor is always kept more than unity over the application band in order to ensure its unconditionally stable implementation to the application system environment. The surface-mount module package including the completed matching circuit and other components necessary just in case allows very simple and convenient implementation onto the system board in mass production level.

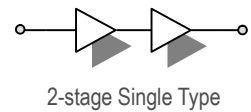

Specifications (in Production)

Typ. @T = 25 °C, $V_s = 5 \text{ V}$, Freq. = 1500 MHz, $Z_{o,sys} = 50 \text{ ohms}$

Parameter	Unit	Specifications		
		Min	Typ	Max
Frequency Range	MHz	1400		1600
Gain	dB	27	28	
Gain Flatness	dB		± 0.6	± 0.8
Noise Figure	dB		0.60	0.65
Output IP3 ⁽¹⁾	dBm	36	38	
S11/S22 ⁽²⁾	dB			-18 / -13
Output P1dB	dBm	20	21	
Switching Time ⁽³⁾	μsec		-	
Supply Current	mA		180	210
Supply Voltage	V		5	
Impedance	Ω		50	
Max. RF Input Power	dBm	C.W 29 ~ 31 (before fail)		
Package Type & Size	mm	Surface Mount Type, 13Wx13Lx3.8H		

Operating temperature is -40 °C to +85 °C.

1) OIP3 is measured with two tones at an output power of 7 dBm/tone separated by 1 MHz.

2) S11, S22 (max) is the worst value within the frequency band.

3) Switching time means the time that takes for output power to get stabilized to its final level after switching DC voltage from 0 V to V_s .

More Information

Website: www.asb.co.kr
E-mail: sales@asb.co.kr

Tel: (82) 42-528-7223
Fax: (82) 42-528-7222

Outline Drawing (Unit: mm)

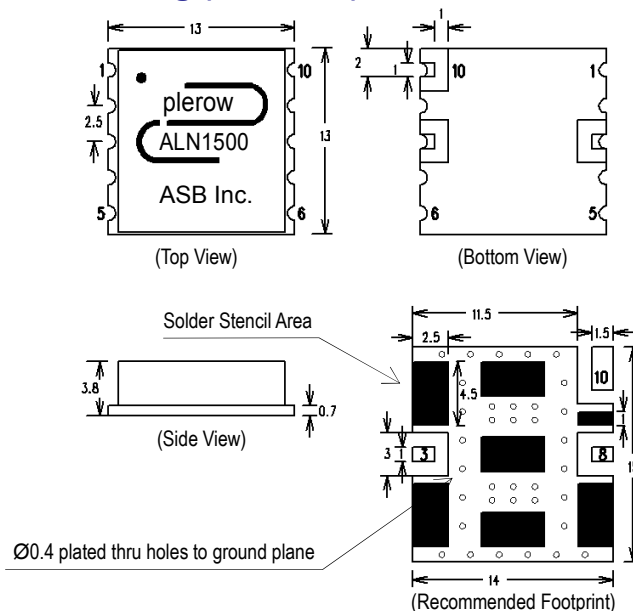

Pin Number	Function
3	RF In
8	RF Out
10	V_s
Others	Ground

Note: 1. The number and size of ground via holes in a circuit board is critical for thermal RF grounding considerations.

2. We recommend that the ground via holes be placed on the bottom of all ground pins for better RF and thermal performance, as shown in the drawing at the left side.

**Typical Performance
(Measured)**

1400~1600 MHz

+5 V

S-parameters

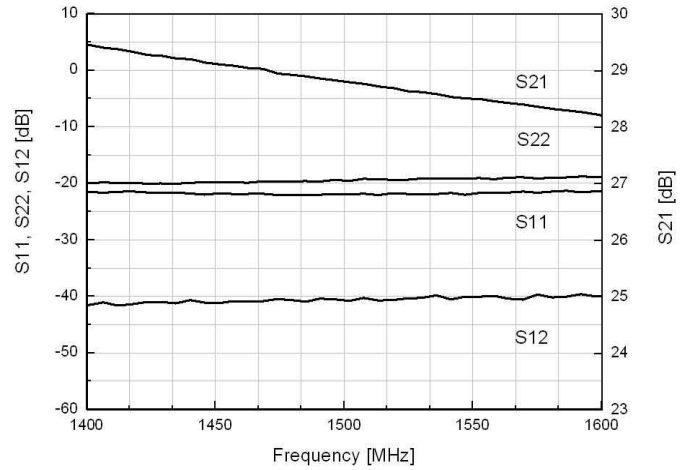

S-parameters & K Factor

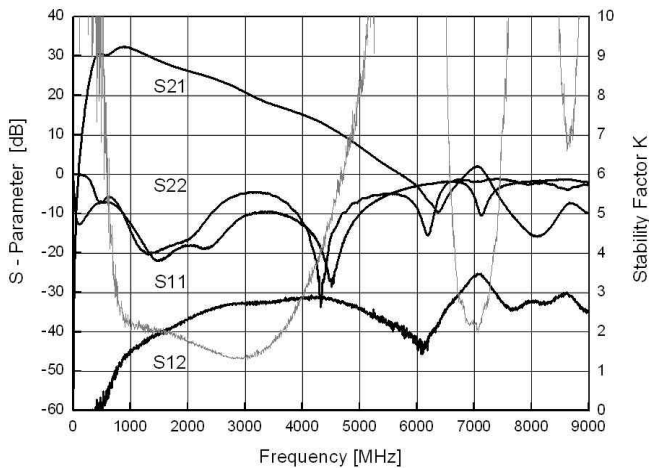

Noise Figure

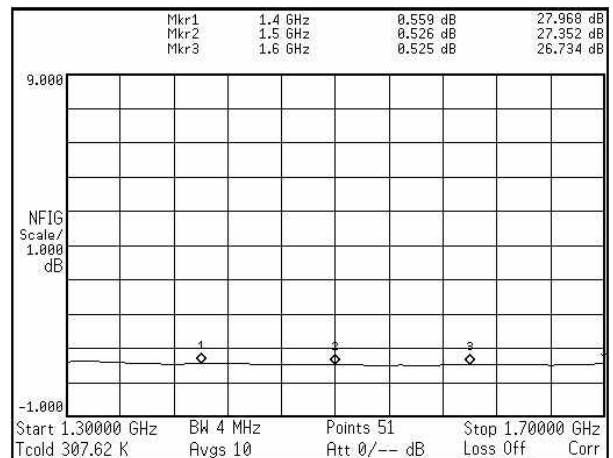

OIP3

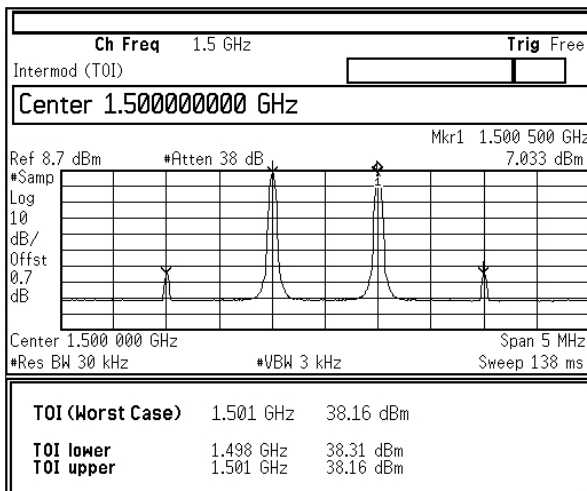

P1dB

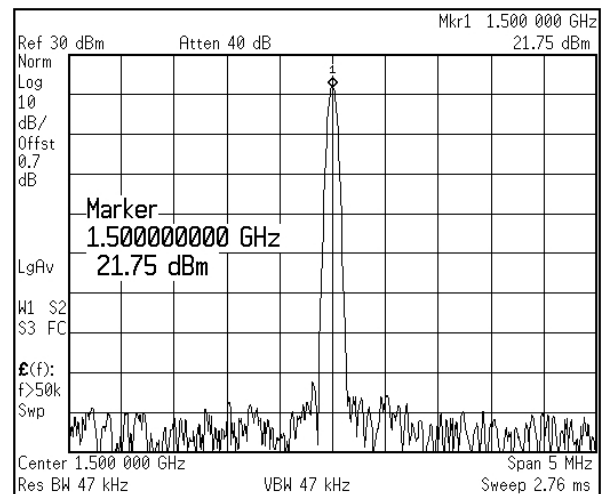

Application Circuit

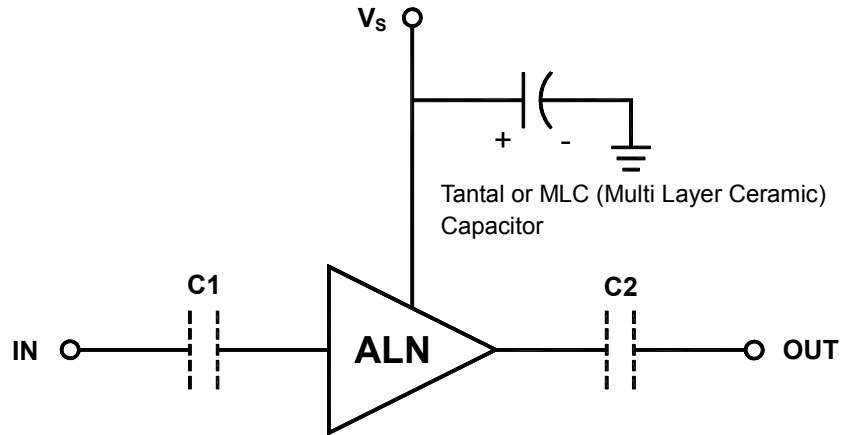

- 1) The tantal or MLC (Multi Layer Ceramic) capacitor is optional and for bypassing the AC noise introduced from the DC supply. The capacitance value may be determined by customer's DC supply status. The capacitor should be placed as close as possible to V_s pin and be connected directly to the ground plane for the best electrical performance.
- 2) DC blocking capacitors are always necessarily placed at the input and output port for allowing only the RF signal to pass and blocking the DC component in the signal. The DC blocking capacitors are included inside the ALN module. Therefore, C1 & C2 capacitors may not be necessary, but can be added just in case that the customer wants. The value of C1 & C2 is determined by considering the application frequency.

Recommended Soldering Reflow Process

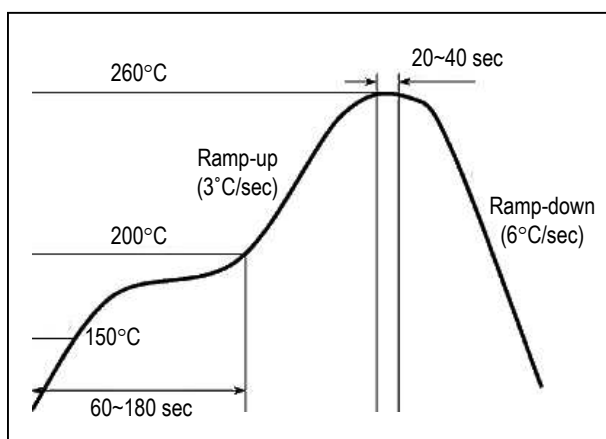

Evaluation Board Layout

