

ASL5543 Data Sheet

High Gain, Low Noise Amplifier

1. Product Overview

1.1 General Description

ASL5543 is a low noise amplifier with high linearity over a wide range of frequency up to 1.7 ~ 3.5 GHz with S11 & S22 < -10 dB. It is also suitable for use in the mobile wireless systems such as PCS, WCDMA, LTE, WiBro, WiMAX, WLAN and so on. It has an active bias circuit for stable current over temperature and process variation. The amplifier is available in SOT343 package and passes the stringent DC, RF and reliability tests.



1.2 Features

- 16.3 dB Gain at 2000 MHz
- 17.0 dBm P1dB at 2000 MHz
- 36.0 dBm Output IP3 at 2000 MHz
- 0.85 dB NF at 2000 MHz
- MTTF > 100 Years
- Single Supply: +3.3 V

1.3 Applications

- Low Noise Amplifier for PCS, WCDMA, WLAN, and WiMAX
- Other Low Noise Application

1.4 Package Profile & RoHS Compliance

 <p>SOT343, 2.15x2.0 mm², surface mount</p>	 <p>RoHS-compliant</p>
---	---

2. Summary on Product Performances

2.1 Typical Performance

Supply voltage = +3.3 V, T_A = +25 °C, Z_O = 50 Ω.

Parameter	Typical				Unit
Frequency	1700	1800	2000	2500	MHz
Gain	17.5	17.1	16.3	14.4	dB
S11	-15.0	-15.0	-15.0	-14.0	dB
S22	-10.0	-11.0	-12.0	-13.0	dB
Noise Figure	0.80	0.80	0.85	0.95	dB
Output IP3 ¹⁾	33.0	35.0	36.0	34.0	dBm
Output P1dB	17.0	17.0	17.0	17.0	dBm
Current	54				mA
Device Voltage	+3.3				V

1) OIP3 is measured with two tones at the output power of +4 dBm/tone separated by 1 MHz.

2.2 Product Specification

Supply voltage = +3.3 V, T_A = +25 °C, Z_O = 50 Ω.

Parameter	Min	Typ	Max	Unit
Frequency		2000		MHz
Gain		16.3		dB
S11		-15.0		dB
S22		-12.0		dB
Noise Figure		0.85		dB
Output IP3		36.0		dBm
Output P1dB		17.0		dBm
Current		54		mA
Device Voltage		+3.3		V

2.3 Pin Configuration

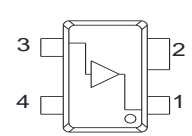
Pin	Description	Simplified Outline
1	RF_OUT & Bias	
2, 4	Ground	
3	RF_IN	

2.4 Absolute Maximum Ratings

Parameters	Max. Ratings
Operation Case Temperature	-40 to +85 °C
Storage Temperature	-40 to +150 °C
Device Voltage	+6 V
Operation Junction Temperature	+150 °C
Input RF Power (CW, 50 Ω matched)	+25 dBm

2.5 Thermal Resistance

Symbol	Description	Typ	Unit
R _{th}	Thermal resistance from junction to lead	110	°C/W

2.6 ESD Classification & Moisture Sensitivity Level

ESD Classification

HBM	Class 1A	Voltage Level: 400 V
MM	Class A	Voltage Level: 50 V

CAUTION: Gallium Arsenide Integrated Circuits are sensitive to electrostatic discharge (ESD) and can be damaged by static electricity. Proper ESD control techniques should be used when handling these devices.

Moisture Sensitivity Level

MSL 3 at 260 °C reflow

(Intentionally Blanked)

3. Application: 1700 ~ 2500 MHz ($V_{\text{supply}} = +3.3 \text{ V}$)

3.1 Application Circuit & Evaluation Board

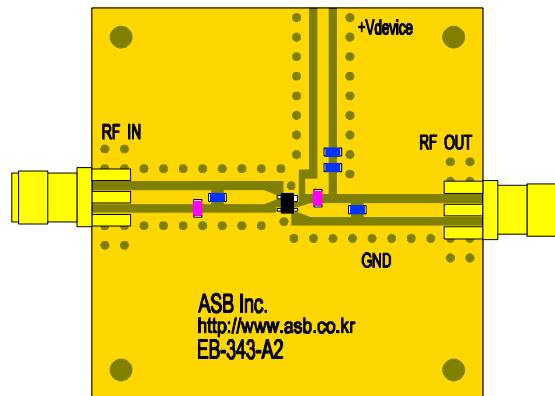
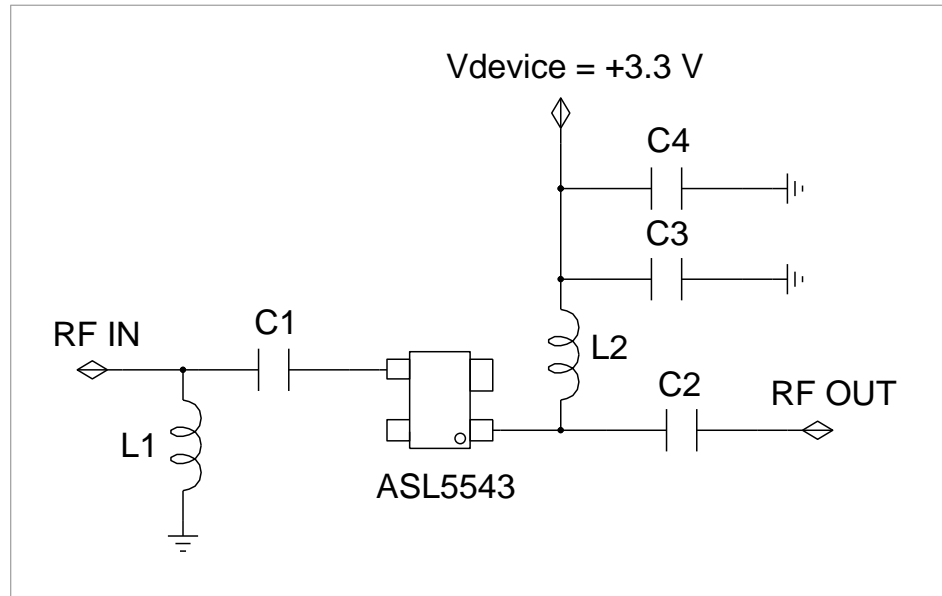

PCB Information	
Material	FR4
Thickness (mm)	0.8
Size (mm)	40x40
EB No.	EB-343-A2

Bill of Material

Symbol	Value	Size	Description	Manufacturer
ASL5543	-	-	MMIC Amplifier	ASB
C1	3 pF	0603	DC block and matching capacitor	Murata
C2	100 pF	0603	DC blocking capacitor	Murata
C3	100 pF	0603	Decoupling capacitor	Murata
C4	1 μ F	0603	Decoupling capacitor	Murata
L1	5.6 nH	0603	Matching inductor	Murata
L2	12 nH	0603	RF choke inductor	Murata

3.2 Performance Table

Supply voltage = +3.3 V, $T_A = +25\text{ }^\circ\text{C}$, $Z_O = 50\ \Omega$.

Parameter	Typical				Unit
Frequency	1700	1800	2000	2500	MHz
Gain	17.5	17.1	16.3	14.4	dB
S11	-15.0	-15.0	-15.0	-14.0	dB
S22	-10.0	-11.0	-12.0	-13.0	dB
Noise Figure	0.80	0.80	0.85	0.95	dB
Output IP3 ¹⁾	33.0	35.0	36.0	34.0	dBm
Output P1dB	17.0	17.0	17.0	17.0	dBm
Current	54				mA
Device Voltage	+3.3				V

1) OIP3 is measured with two tones at the output power of +4 dBm/tone separated by 1 MHz.

3.3 Plot of S-parameter & Stability Factor

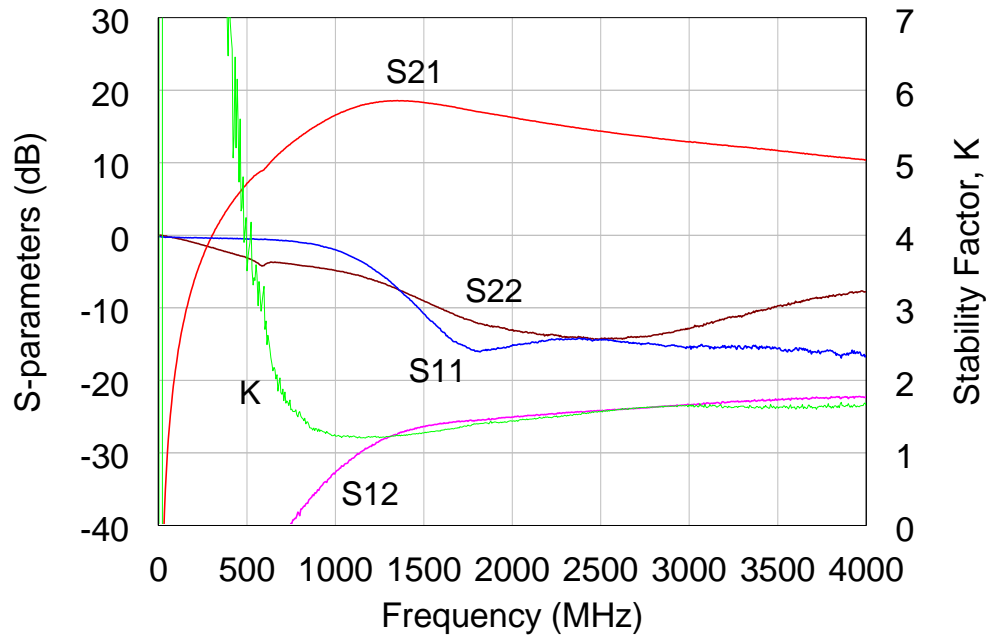

3.4 Plot of Noise Figure

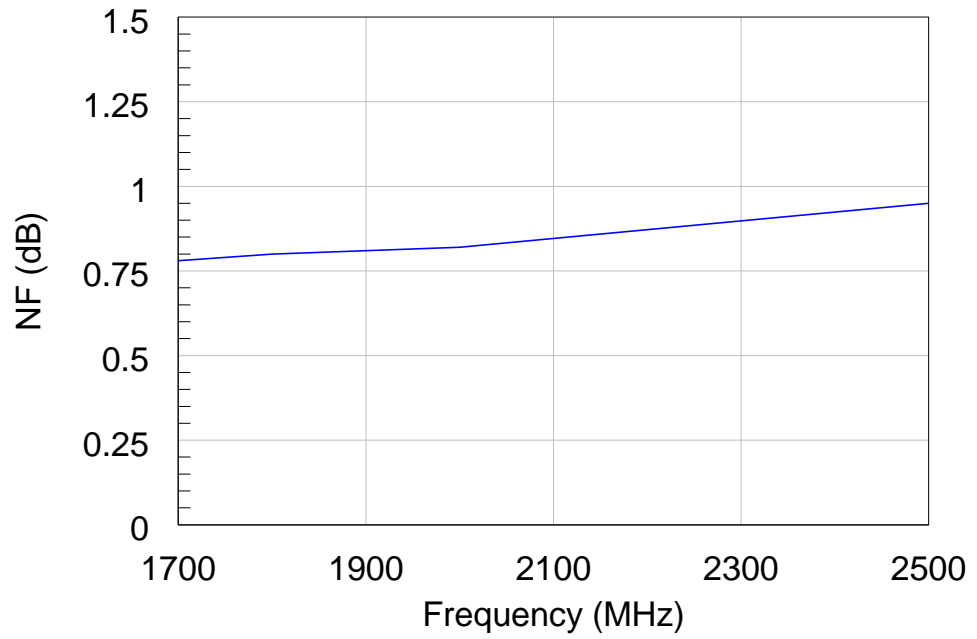

3.5 Plots of Noise Figure and Performances with Temperature

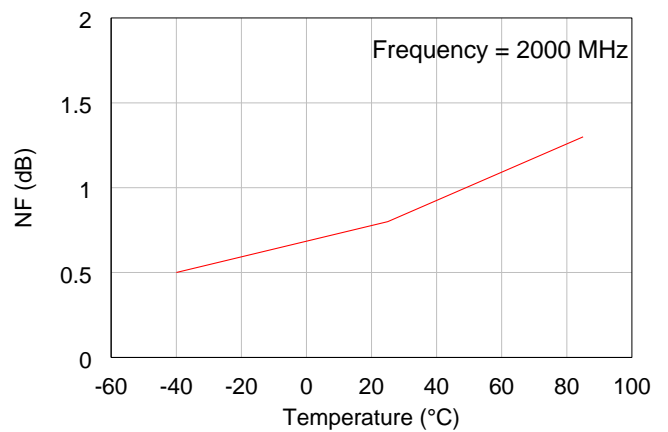
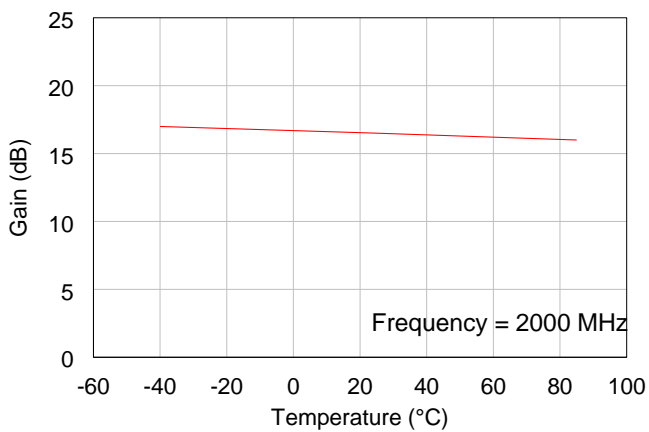
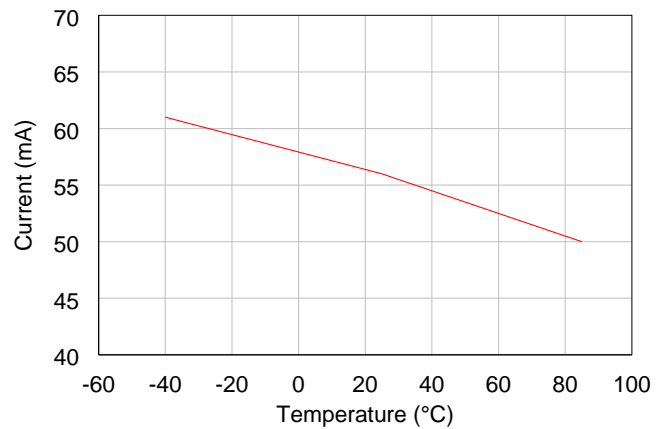
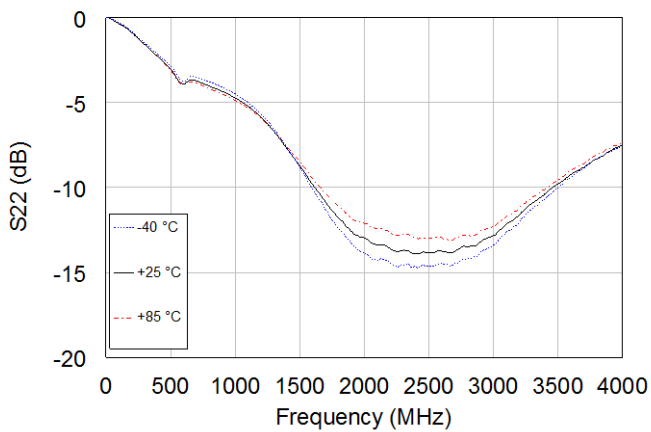
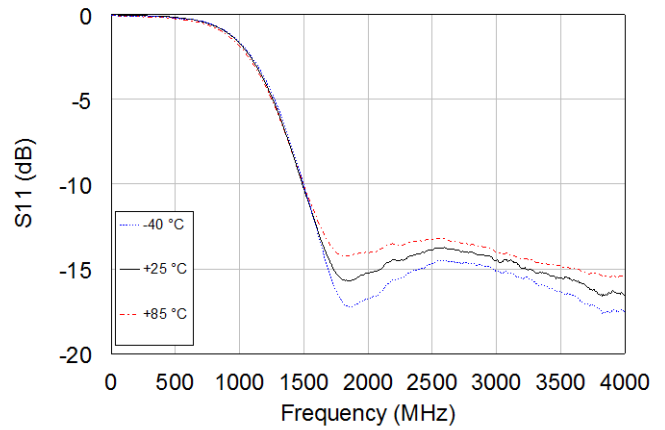
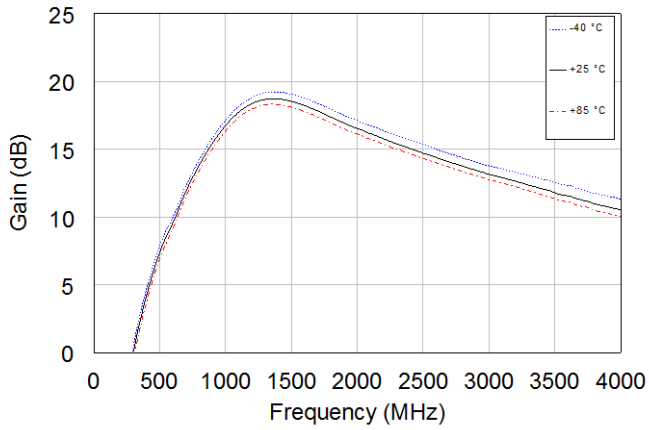

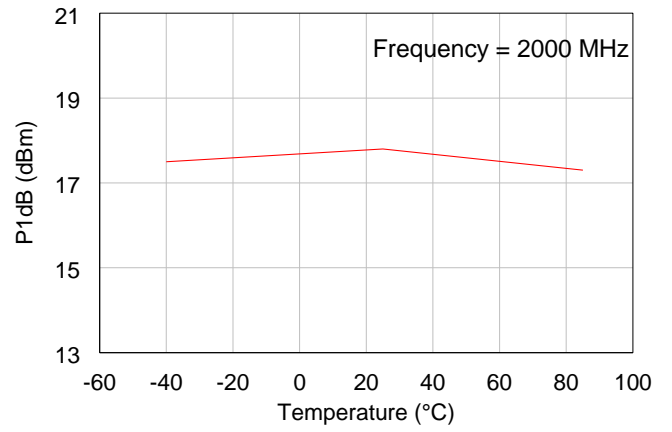
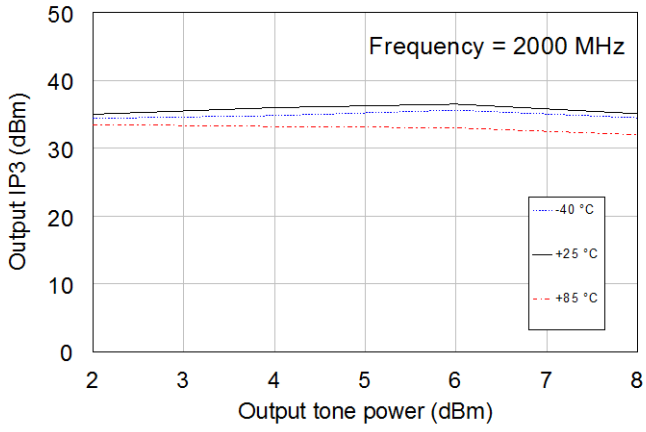

4. Package Outline (SOT343, 2.15x2.0x1.0 mm)

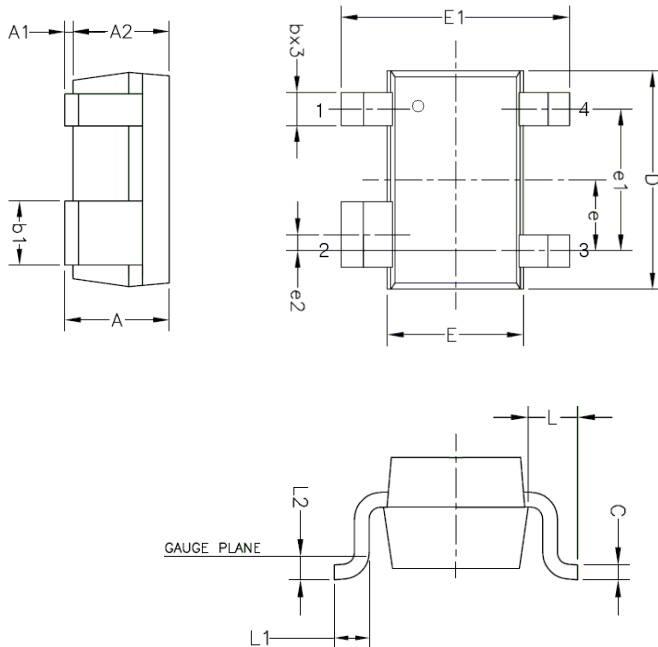

Symbols	Dimensions (In mm)	
	MIN	MAX
A	0.90	1.10
A1	0.025	0.10
A2	0.875	1.00
b	0.20	0.40
b1	0.50	0.70
C	0.10	0.15
D	1.90	2.10
E	1.15	1.35
E1	2.00	2.30
e	0.65BSC	
e1	1.30BSC	
e2	0.15BSC	
L	0.425REF	
L1	0.300REF	
L2	0.200REF	

5. Surface Mount Recommendation (In mm)

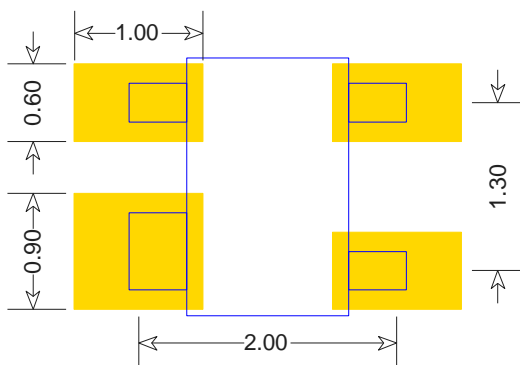

6. Recommended Soldering Reflow Profile

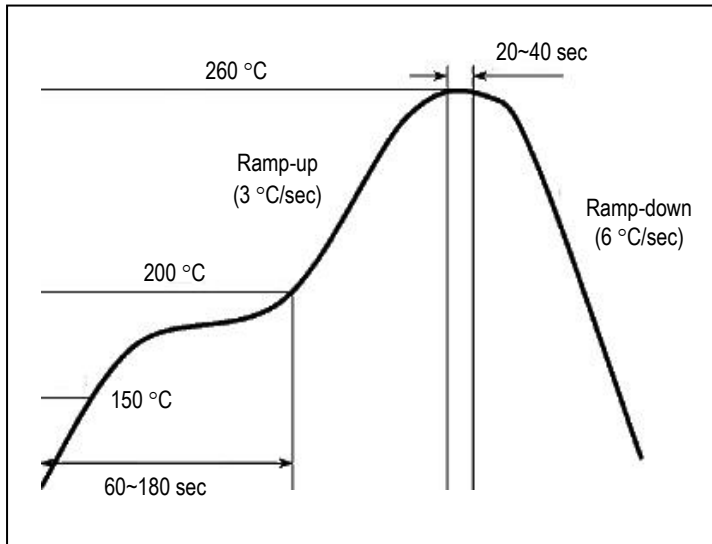

(End of Datasheet)

Copyright ©2014-2017 ASB Inc. All rights reserved. Datasheet subject to change without notice. ASB assumes no responsibility for any errors which may appear in this datasheet. No part of the datasheet may be copied or reproduced in any form or by any means without the prior written consent of ASB.